

Infantil villa aviles 14 01/11/2014 Avilés Inf F -36

Competidores: 8

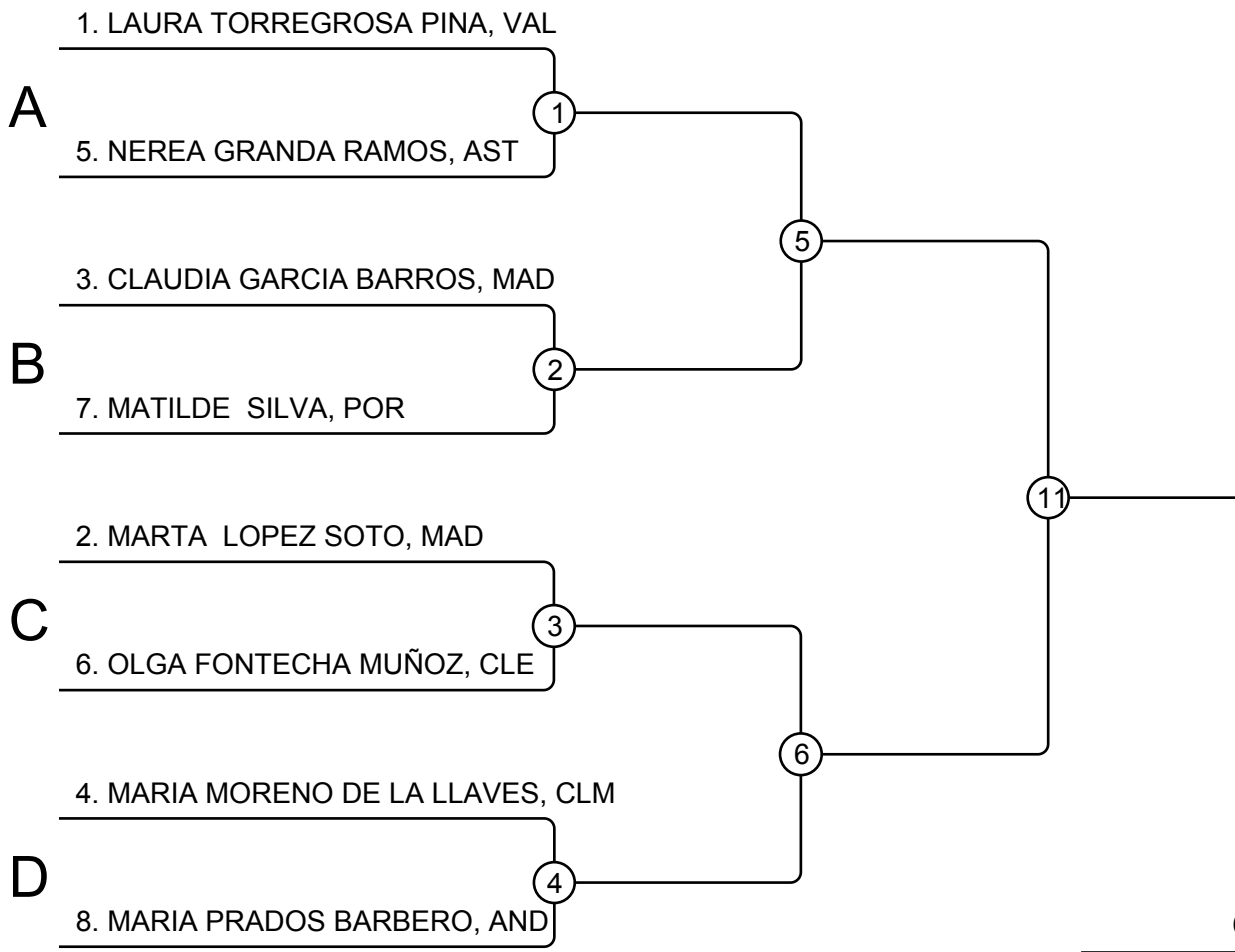

Clasificación

Pos.	Nombre
1	
2	
3	
3	
5	
5	
7	
7	

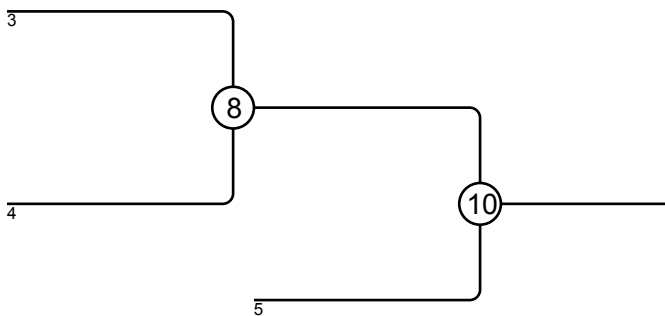
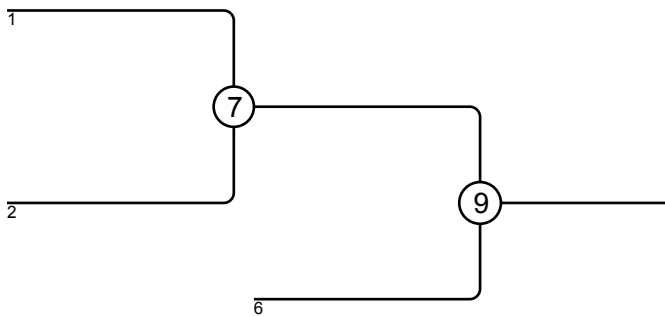

Infantil villa aviles 14 01/11/2014 Avilés Inf F -40

Competidores: 13

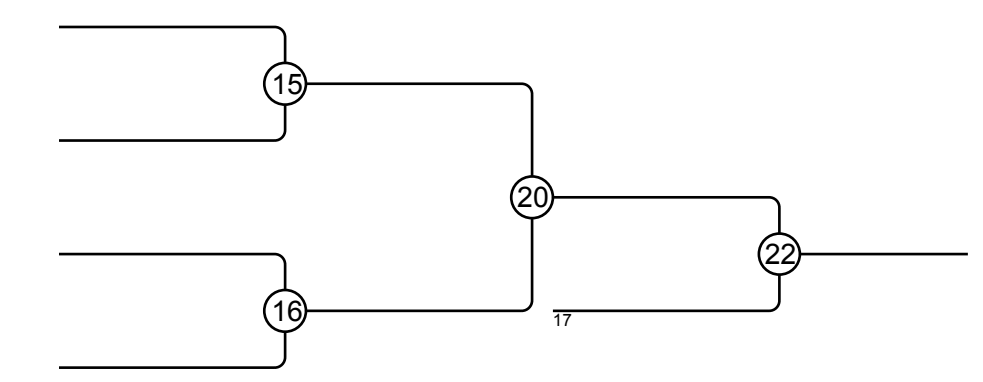
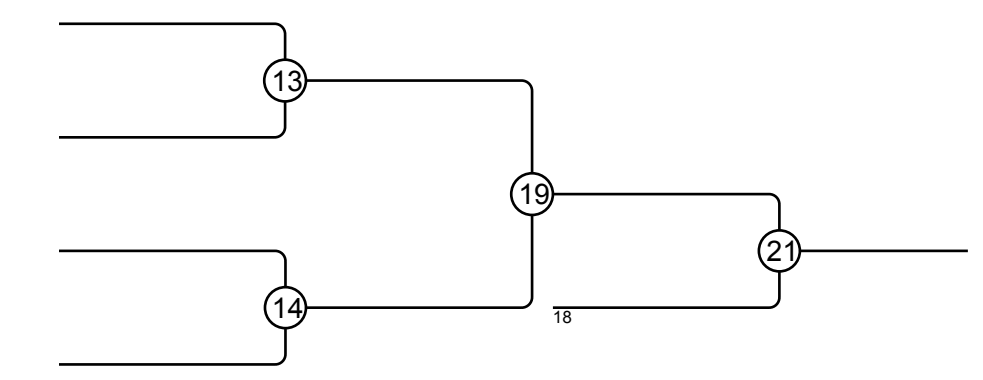
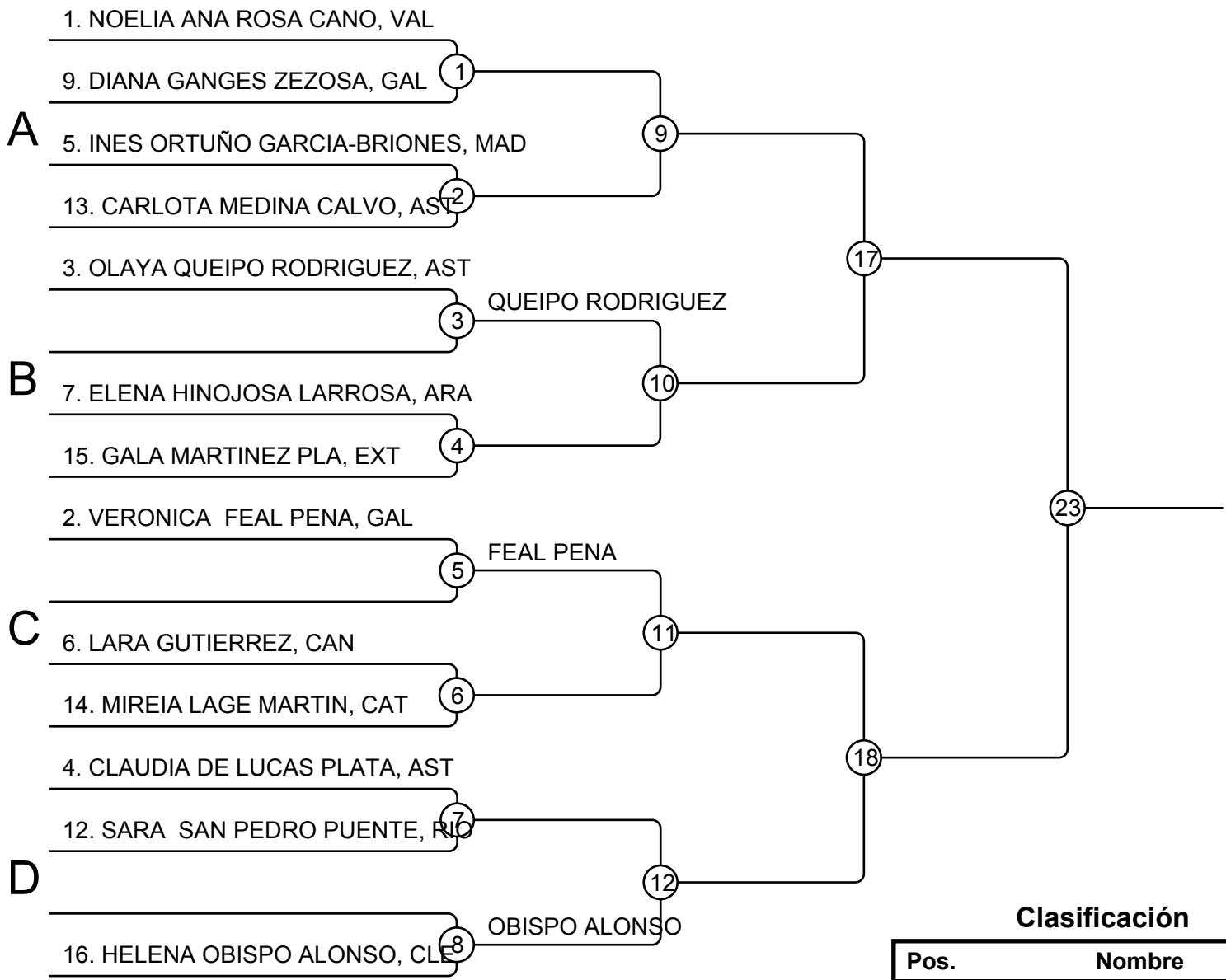

Clasificación

Pos.	Nombre
1	
2	
3	
3	
5	
5	
7	
7	

Infantil villa aviles 14 01/11/2014 Avilés Inf F -44

Competidores: 19

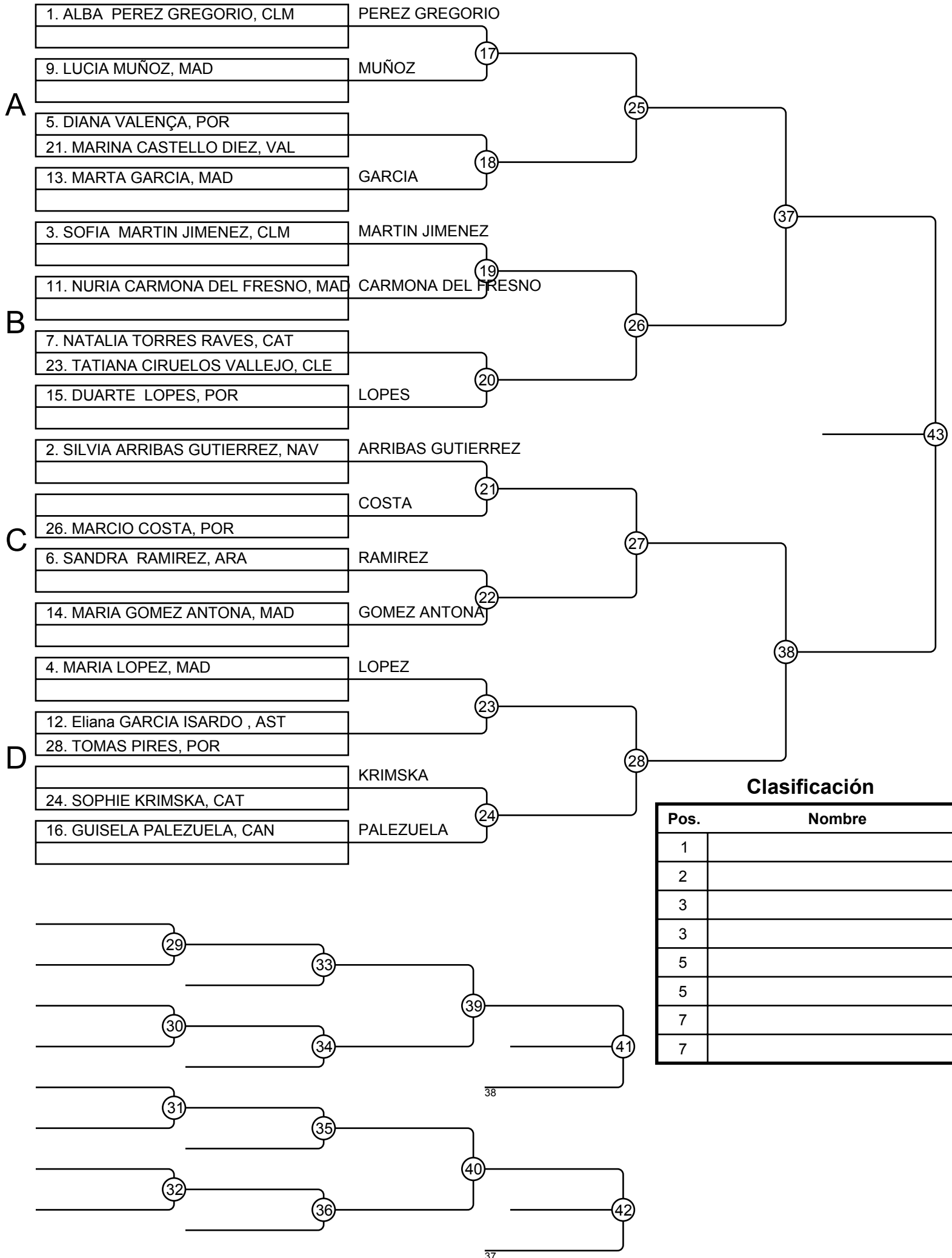

Infantil villa aviles 14 01/11/2014 Avilés Inf F -48

Competidores: 24

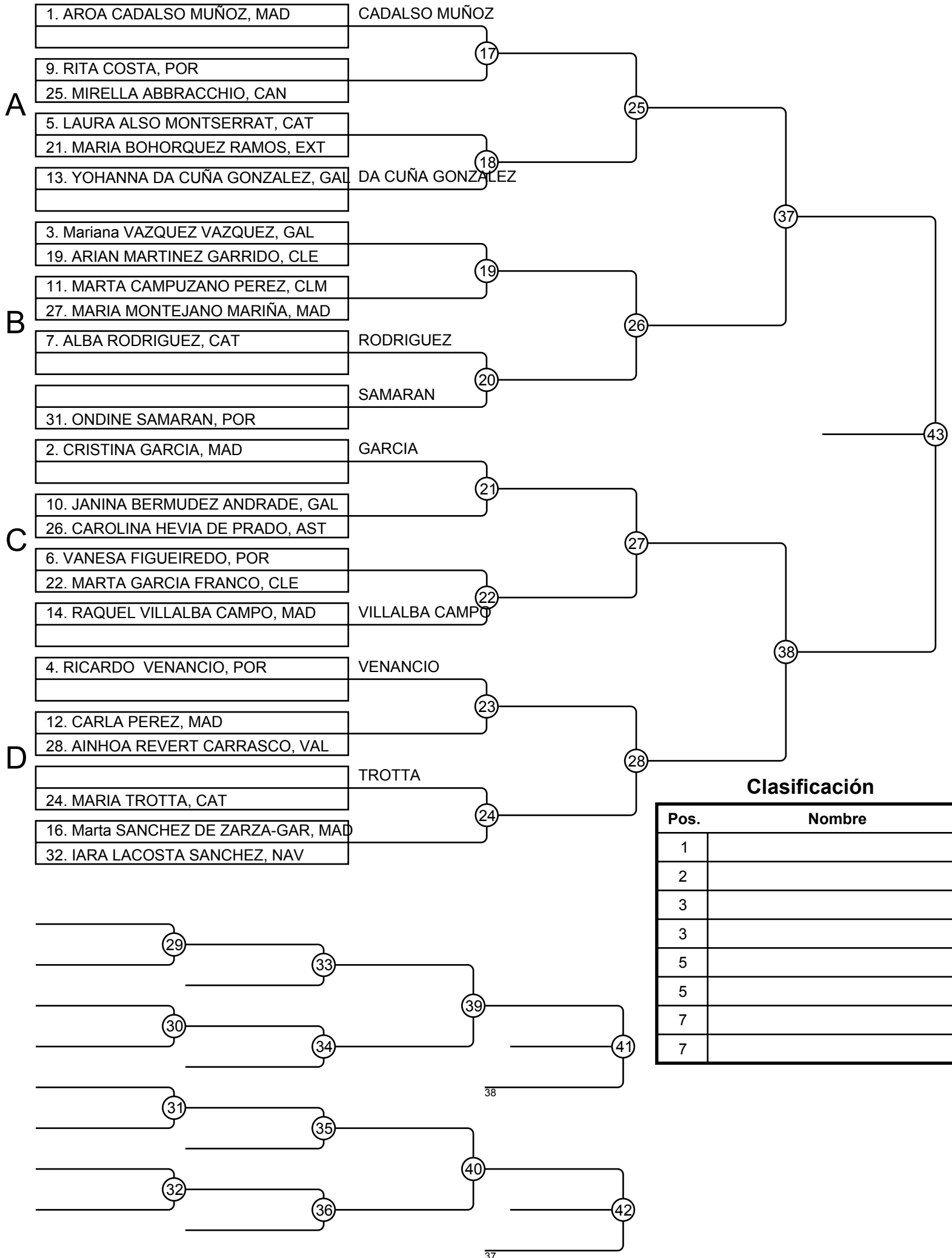

Infantil villa aviles 14 01/11/2014 Avilés Inf F -52

Competidores: 14

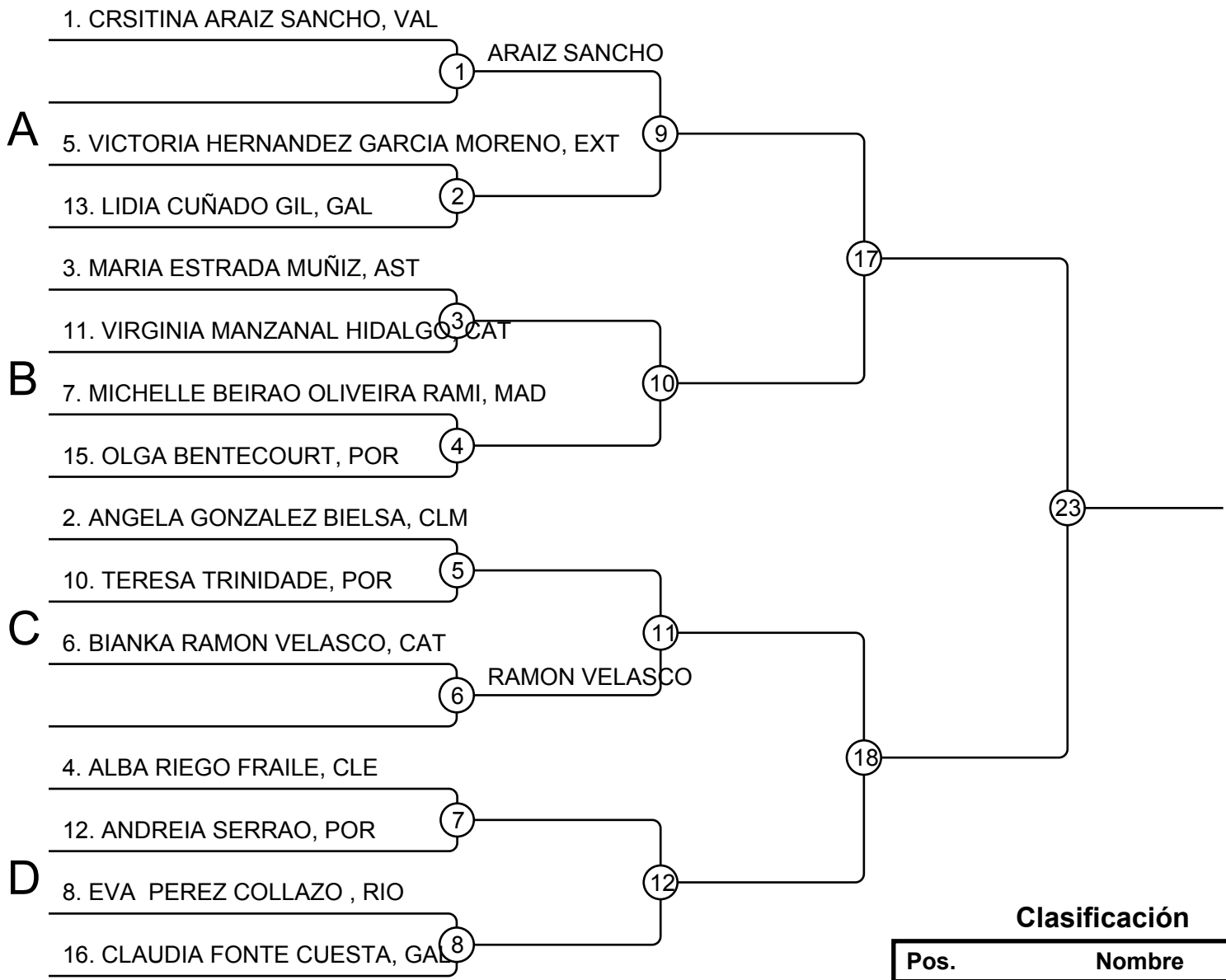

Clasificación

Pos.	Nombre
1	
2	
3	
3	
5	
5	
7	
7	

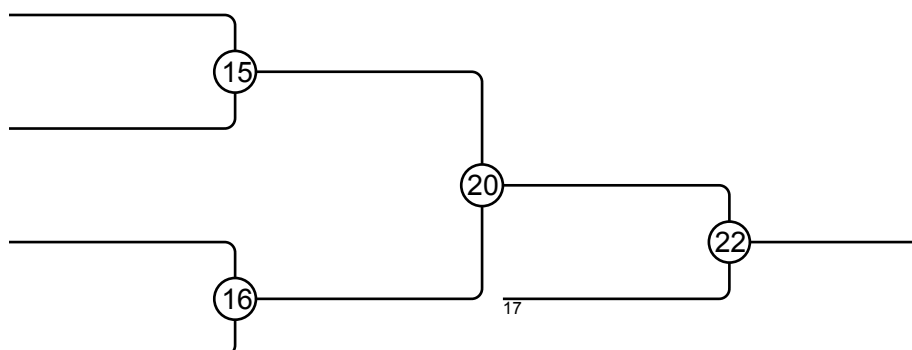
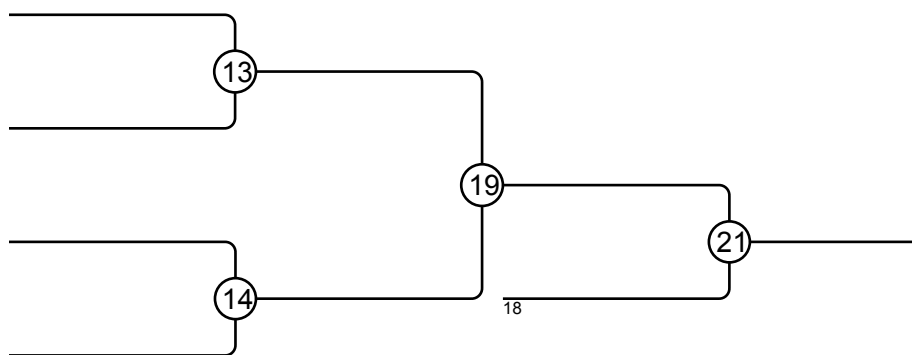

Infantil villa aviles 14 01/11/2014 Avilés Inf F -57

Competidores: 16

1. JULIA RIBERA VERGES, CAT

9. ALBA M^a DE LAS ROSAS ROJAS, AND

5. JENNIFER PAOLA RAMIREZ ROJAS, CAN

13. LAURA DEL ROSAL SUAREZ, AST

3. SOFIA BLANCO ALONSO, AST

11. LILIANA CARVALHO, POR

7. HENAR BAZ LOMBA, GAL

15. Maria REY, MAD

2. ELSA FERNANDEZ FRAGA, AST

10. PAULA CAMPO, ARA

6. YAIZA VIERA BARRIENTOS, MAD

14. DANIELA DANIELA, CAN

4. NURIA RODRIGUEZ LOSA, CAT

12. LEONOR COSTA, POR

8. LYDIA VALDIVIESO ESTALRICH, MAD

16. SOFIA BARRAGANS MARTINEZ, AST

A

B

C

D

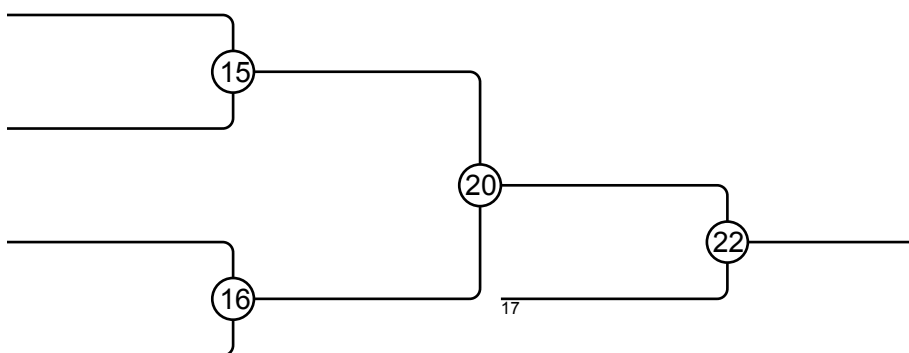
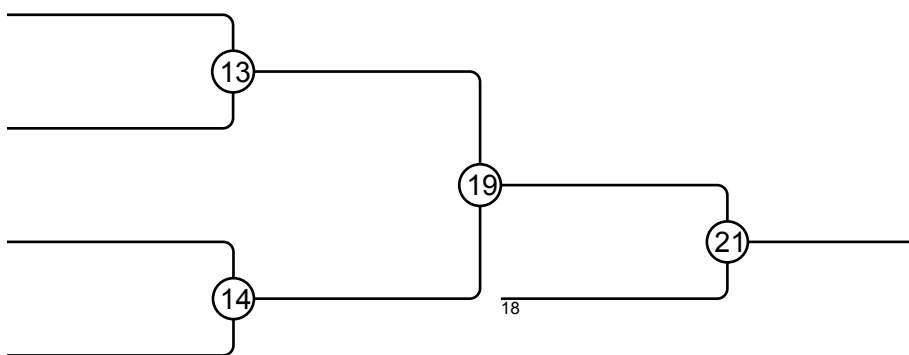

Clasificación

Pos.	Nombre
1	
2	
3	
3	
5	
5	
7	
7	

Infantil villa aviles 14 01/11/2014 Avilés Inf F -63

Competidores: 9

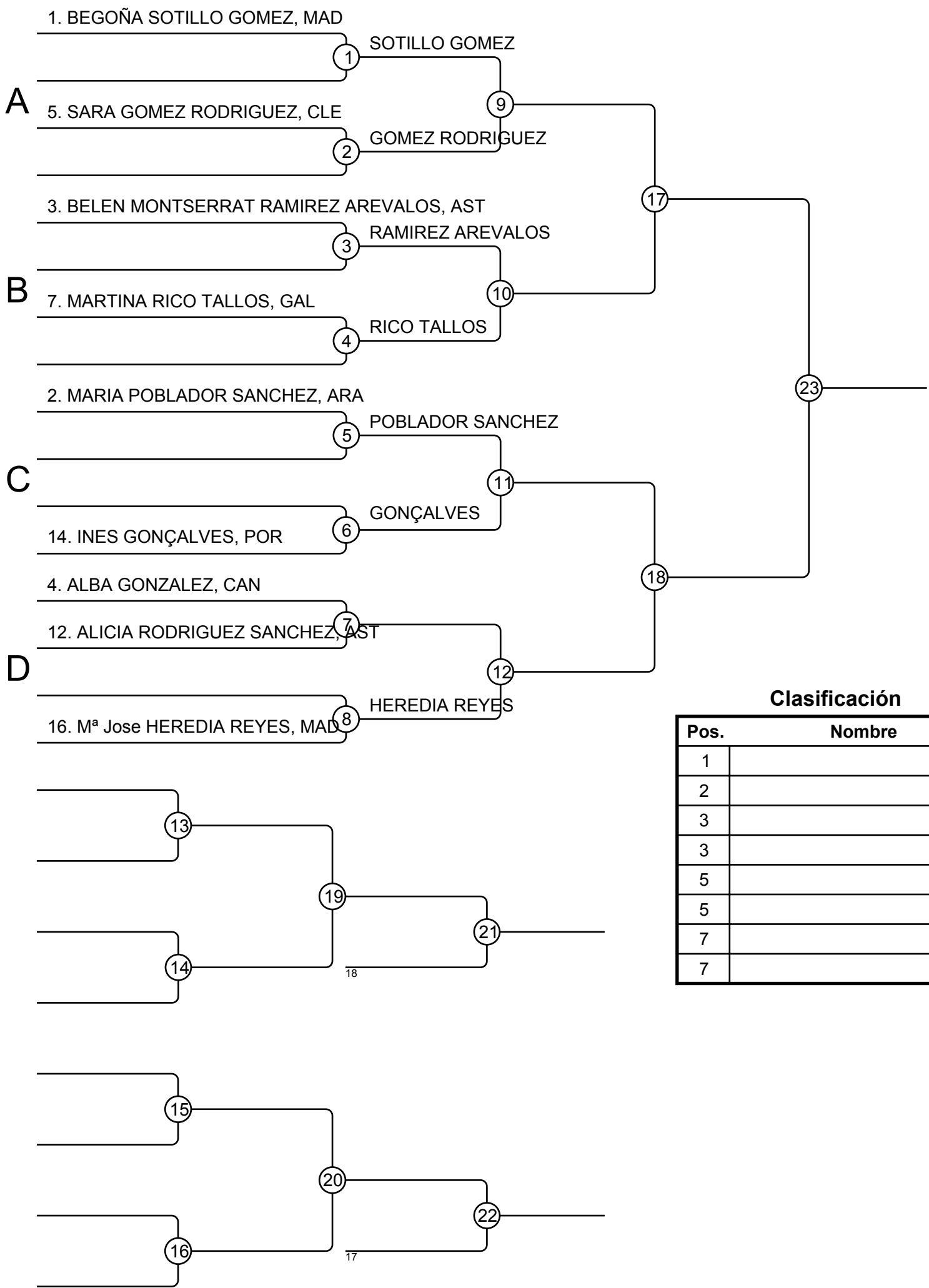

Clasificación

Pos.	Nombre
1	
2	
3	
3	
5	
5	
7	
7	

Infantil villa aviles 14 01/11/2014 Avilés Inf F +63

Competidores: 6

1. NEREA HERNANDEZ LAVILLE, VAL

A

1 HERNANDEZ LAVILLE

3. YAIZA PEREZ MARTINEZ, AST

B

2

7. M^a José PADRO, EXT

2. LUCIA GARCIA GALAN, AST

C

3 GARCIA GALAN

4. EVA REY CASTILLO, AST

D

4

8. AIDA MARIANA RIBEIRO PINTO, POR

5

11

6

Clasificación

Pos.	Nombre
1	
2	
3	
3	
5	
5	
7	
7	

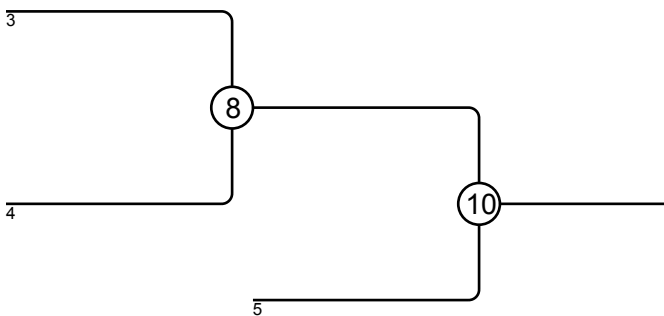
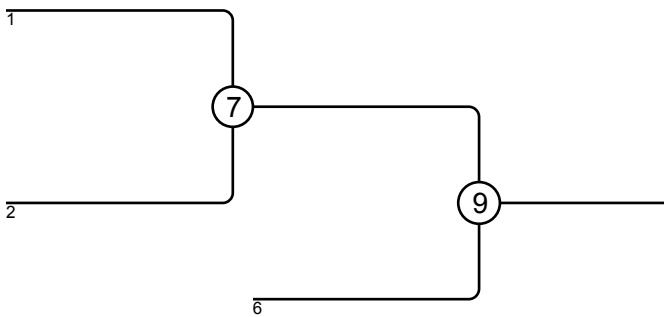

Infantil villa aviles 14 01/11/2014 Avilés Inf M -38 (1/3)

Competidores: 35

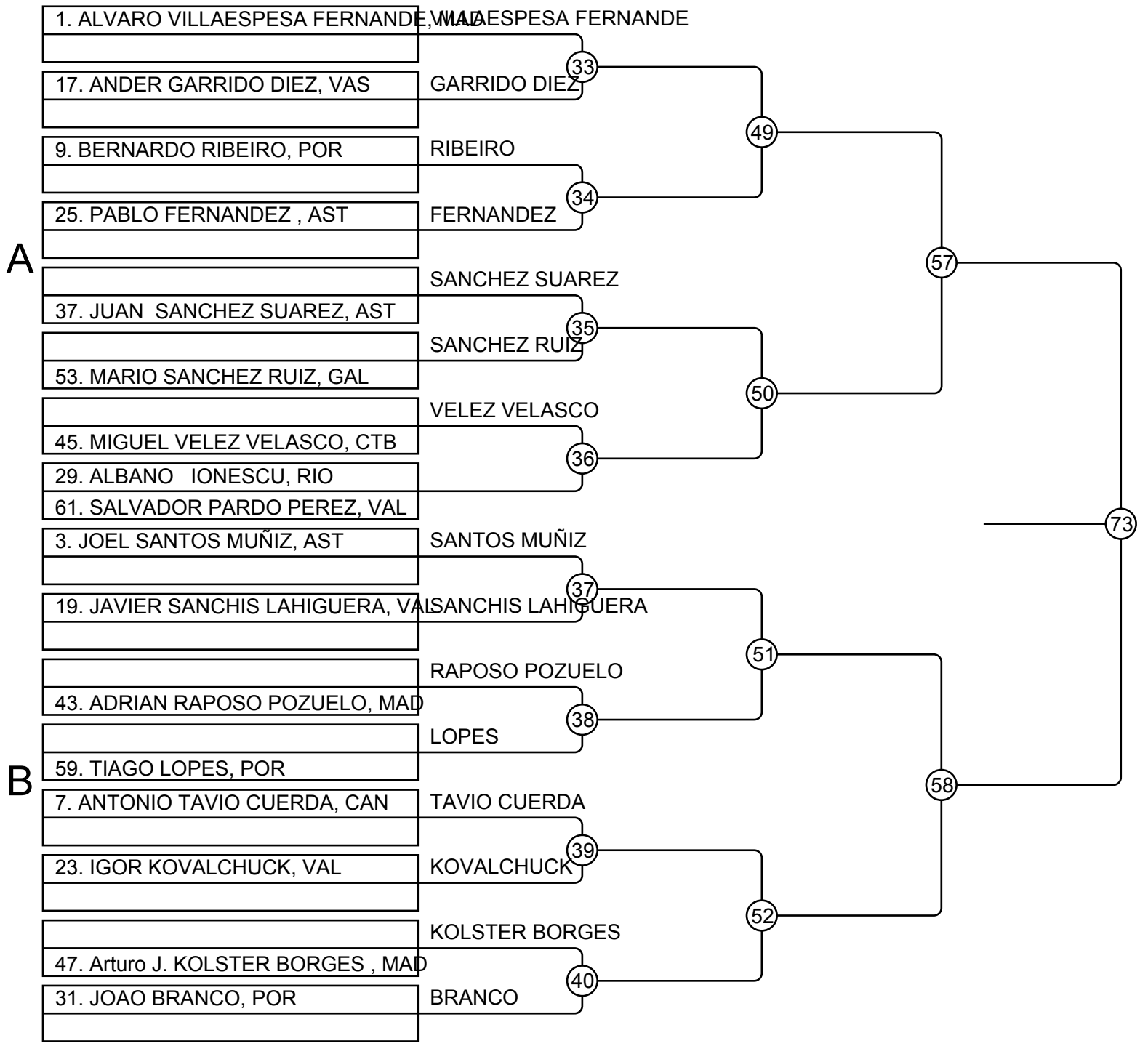

Infantil villa aviles 14 01/11/2014 Avilés Inf M -38 (2/3)

Competidores: 35

C

D

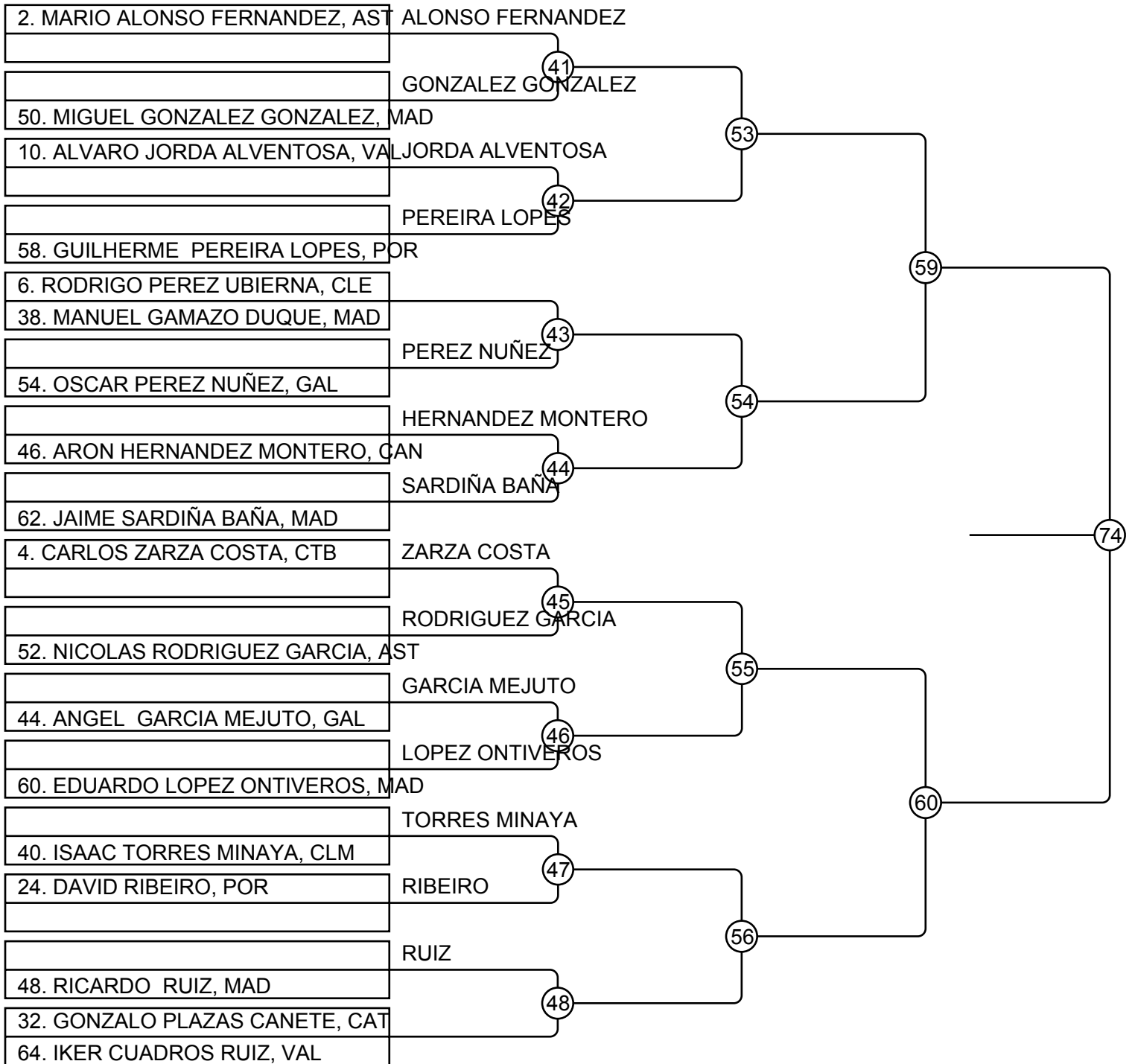

Infantil villa aviles 14 01/11/2014 Avilés Inf M -38 (3/3)

Competidores: 35

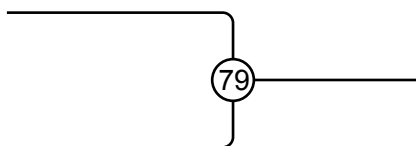
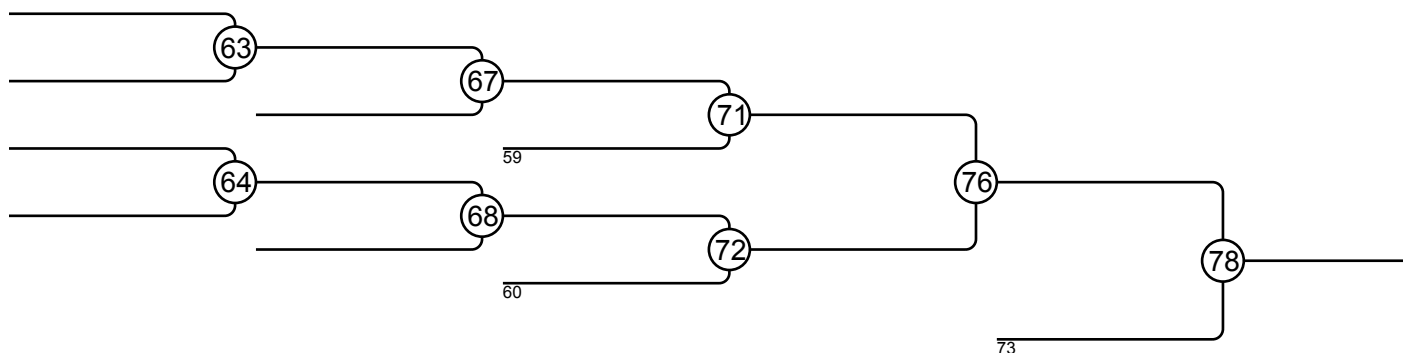
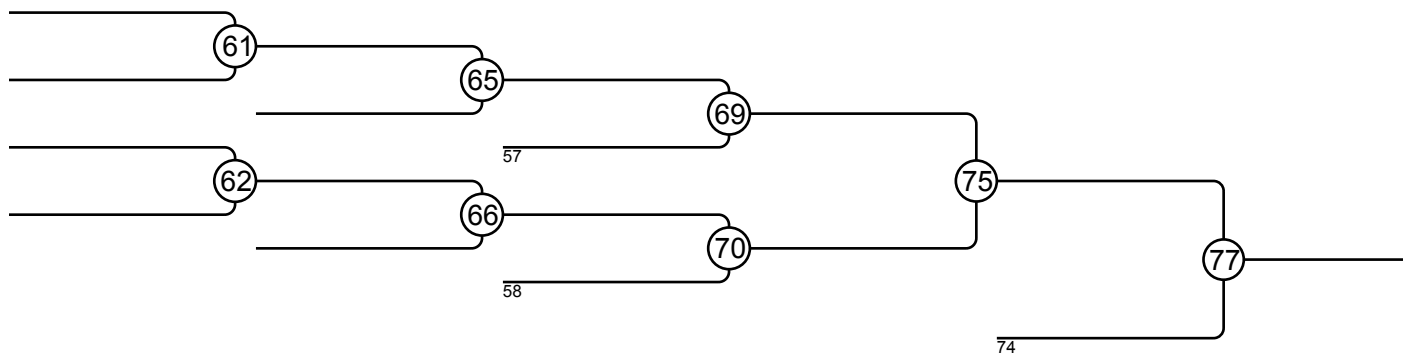

Clasificación

Pos.	Nombre
1	
2	
3	
3	
5	
5	
7	
7	

Infantil villa aviles 14 01/11/2014 Avilés Inf M -42 (1/3)

Competidores: 39

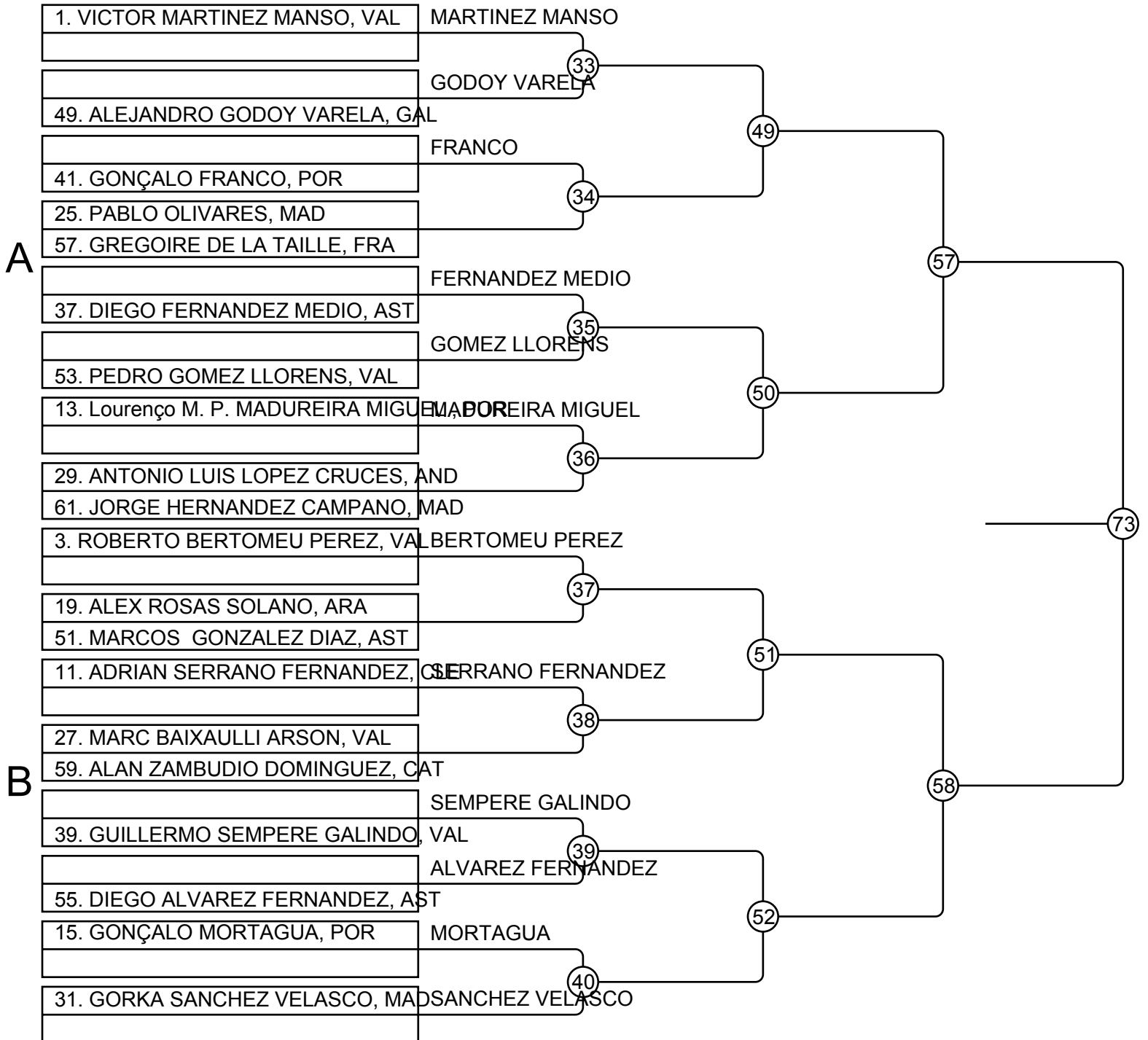

Infantil villa aviles 14 01/11/2014 Avilés Inf M -42 (2/3)

Competidores: 39

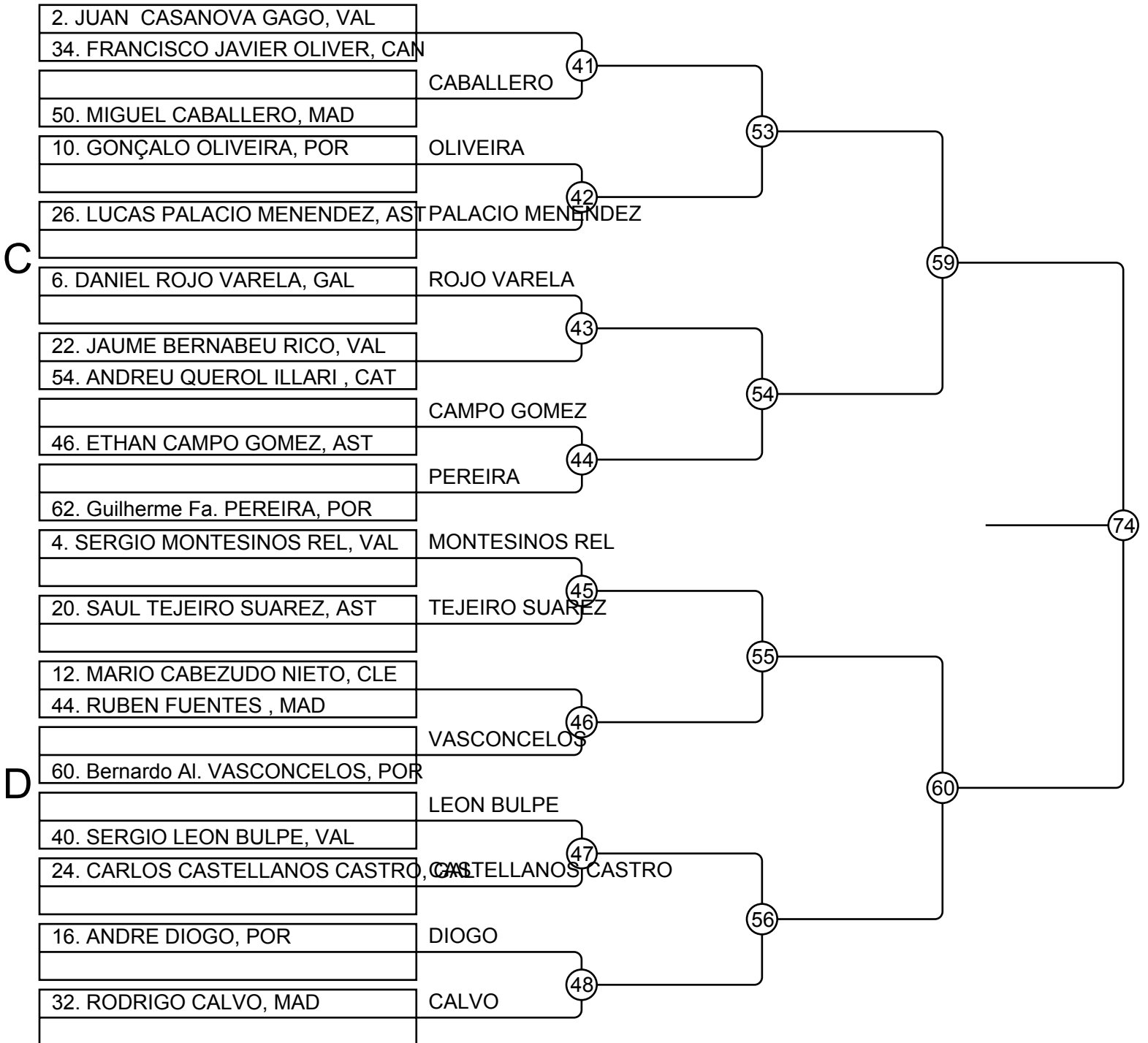

Infantil villa aviles 14 01/11/2014 Avilés Inf M -42 (3/3)

Competidores: 39

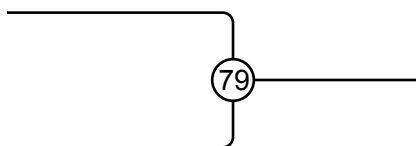
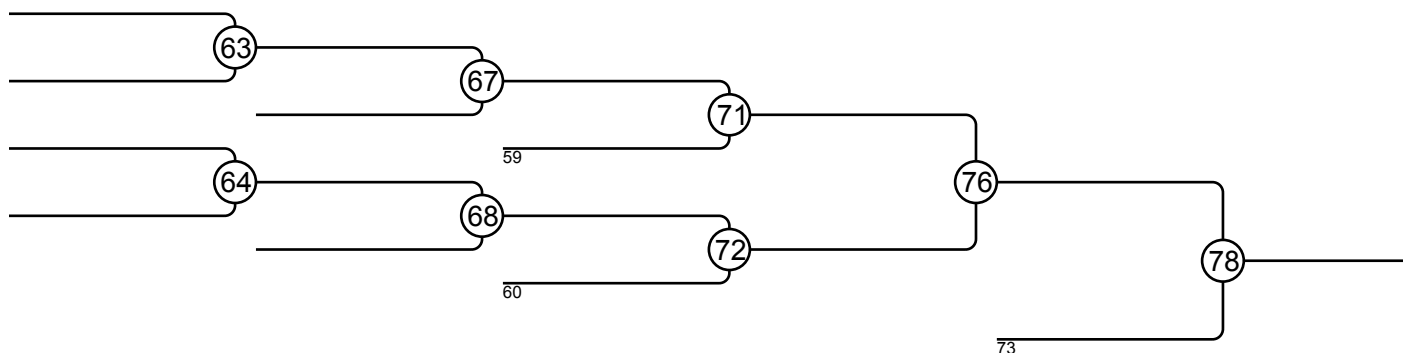
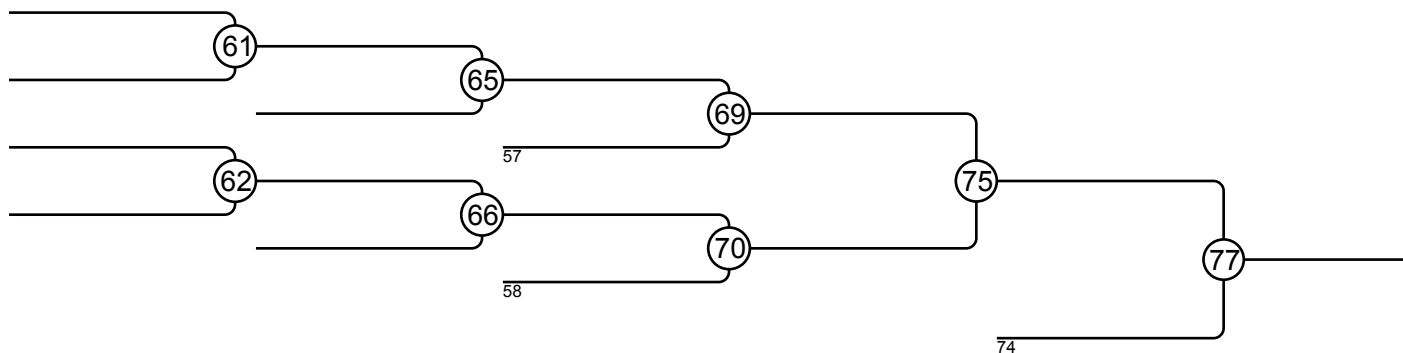

Clasificación

Pos.	Nombre
1	
2	
3	
3	
5	
5	
7	
7	

Infantil villa aviles 14 01/11/2014 Avilés Inf M -46 (1/3)

Competidores: 46

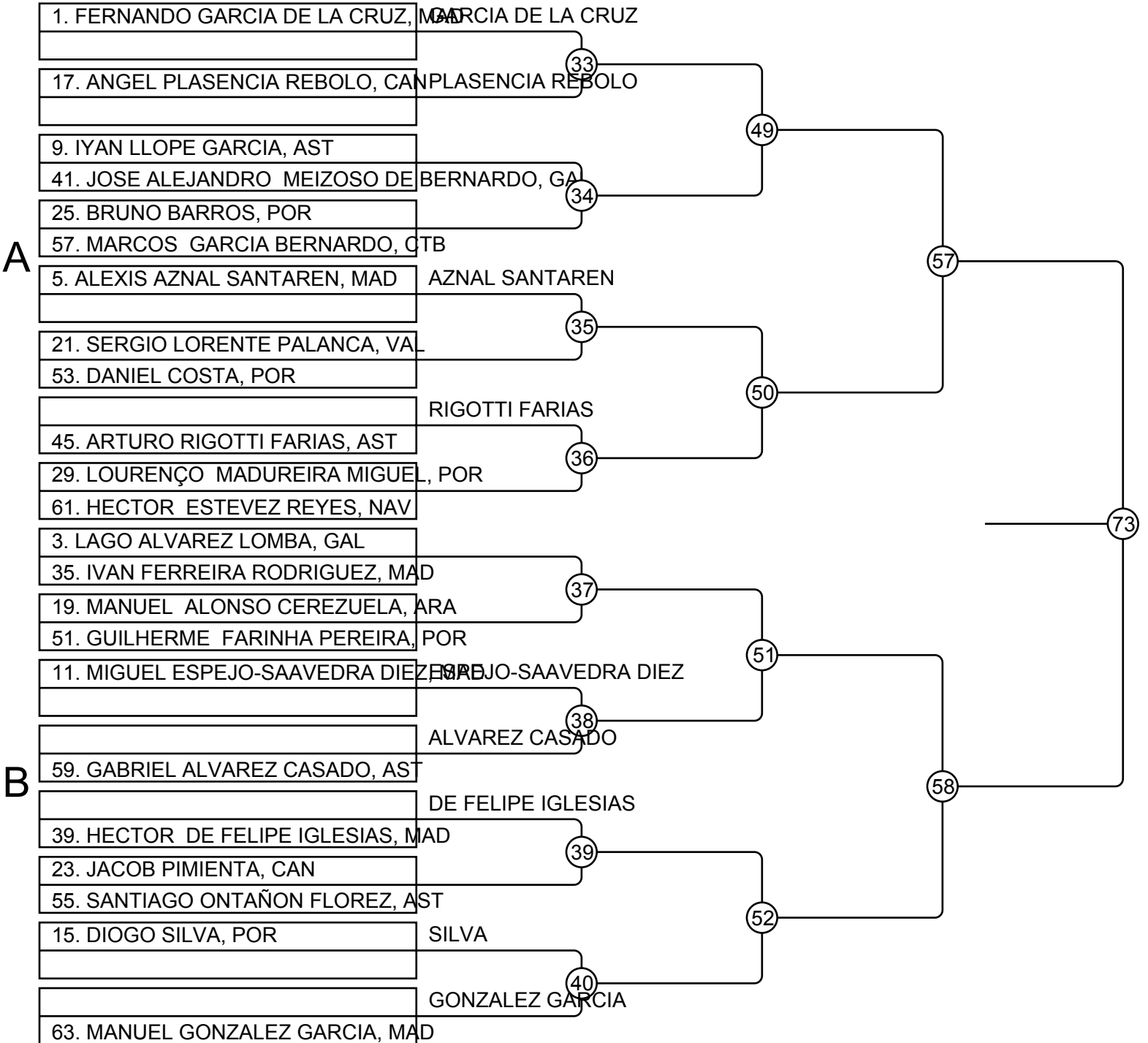

Infantil villa aviles 14 01/11/2014 Avilés Inf M -46 (2/3)

Competidores: 46

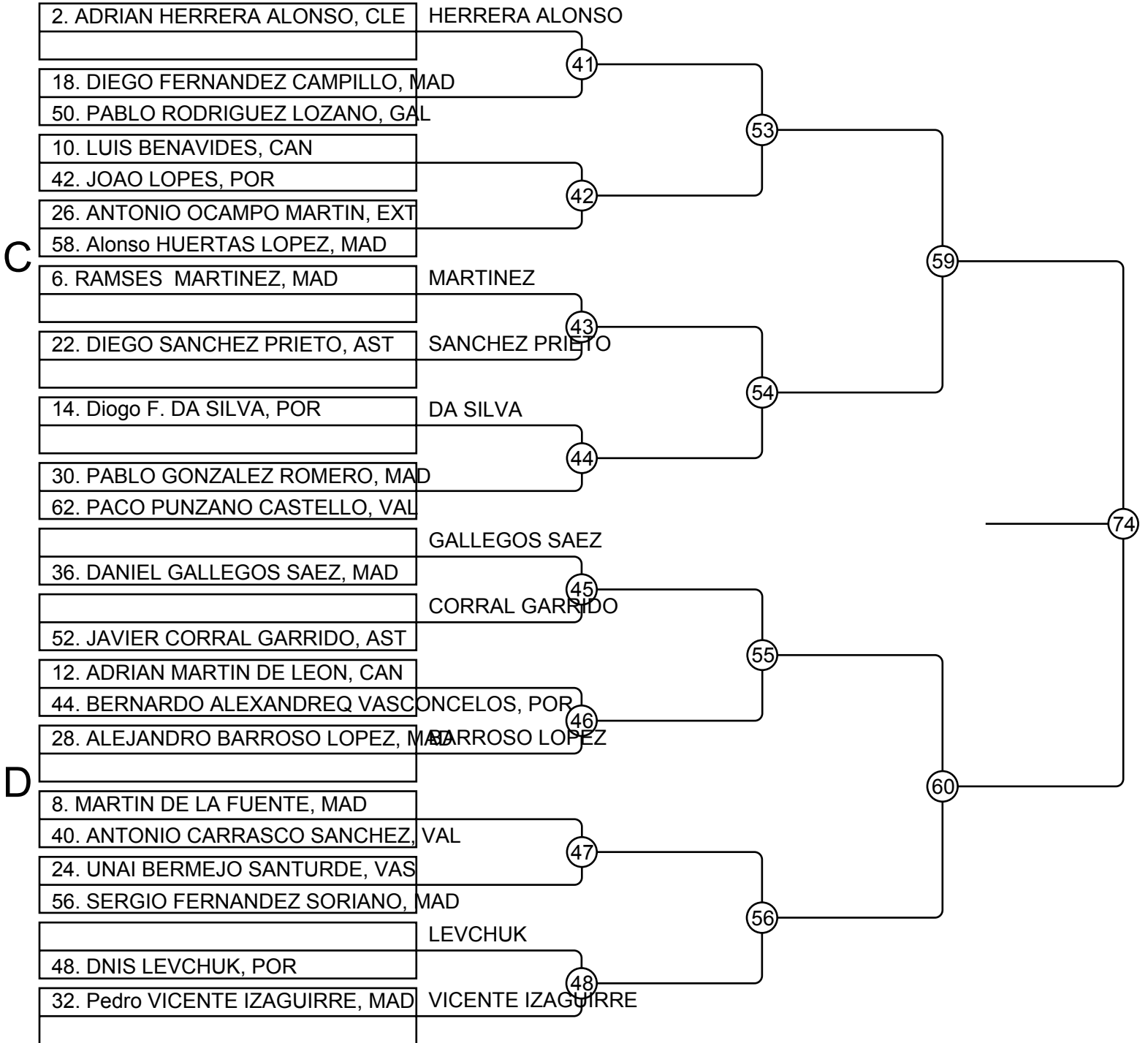

Infantil villa aviles 14 01/11/2014 Avilés Inf M -46 (3/3)

Competidores: 46

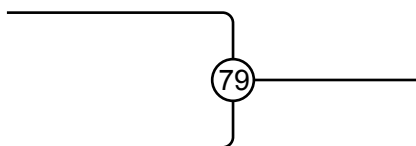
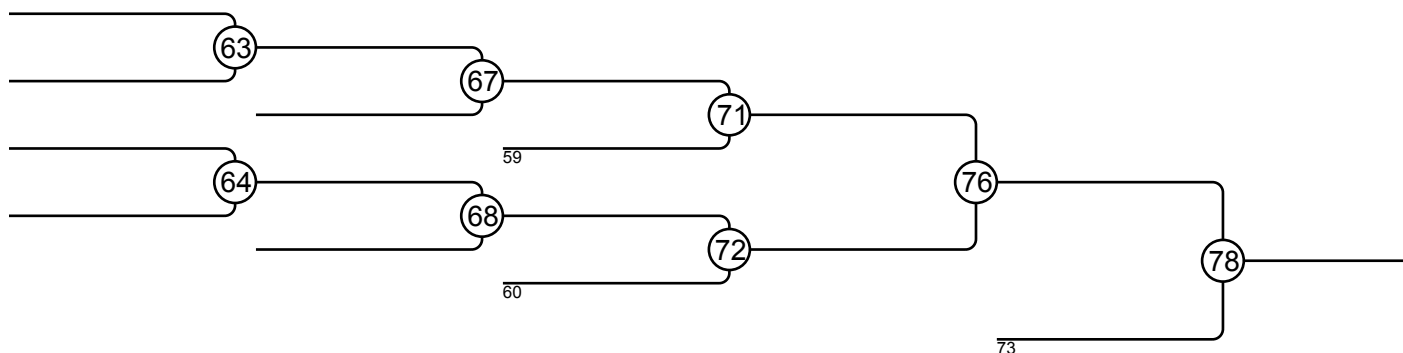
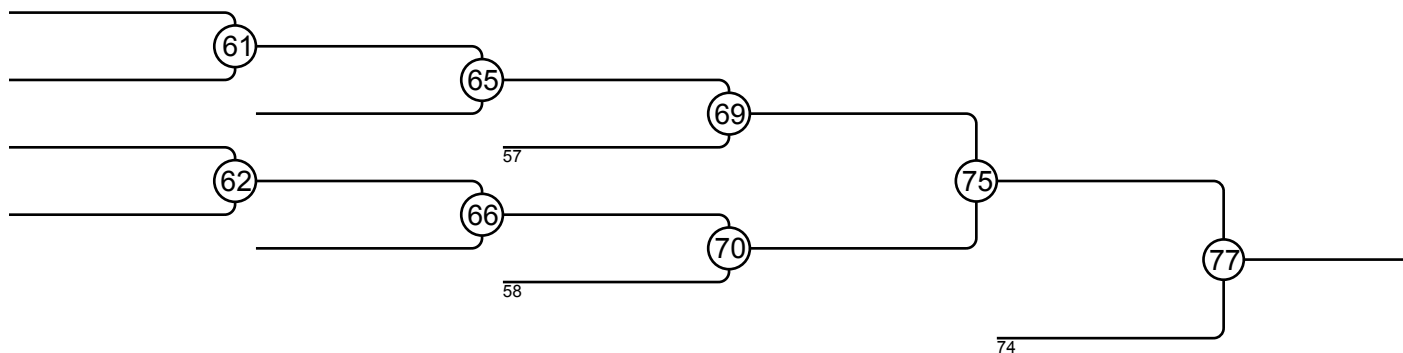

Clasificación

Pos.	Nombre
1	
2	
3	
3	
5	
5	
7	
7	

Infantil villa aviles 14 01/11/2014 Avilés Inf M -50 (1/3)

Competidores: 41

A

B

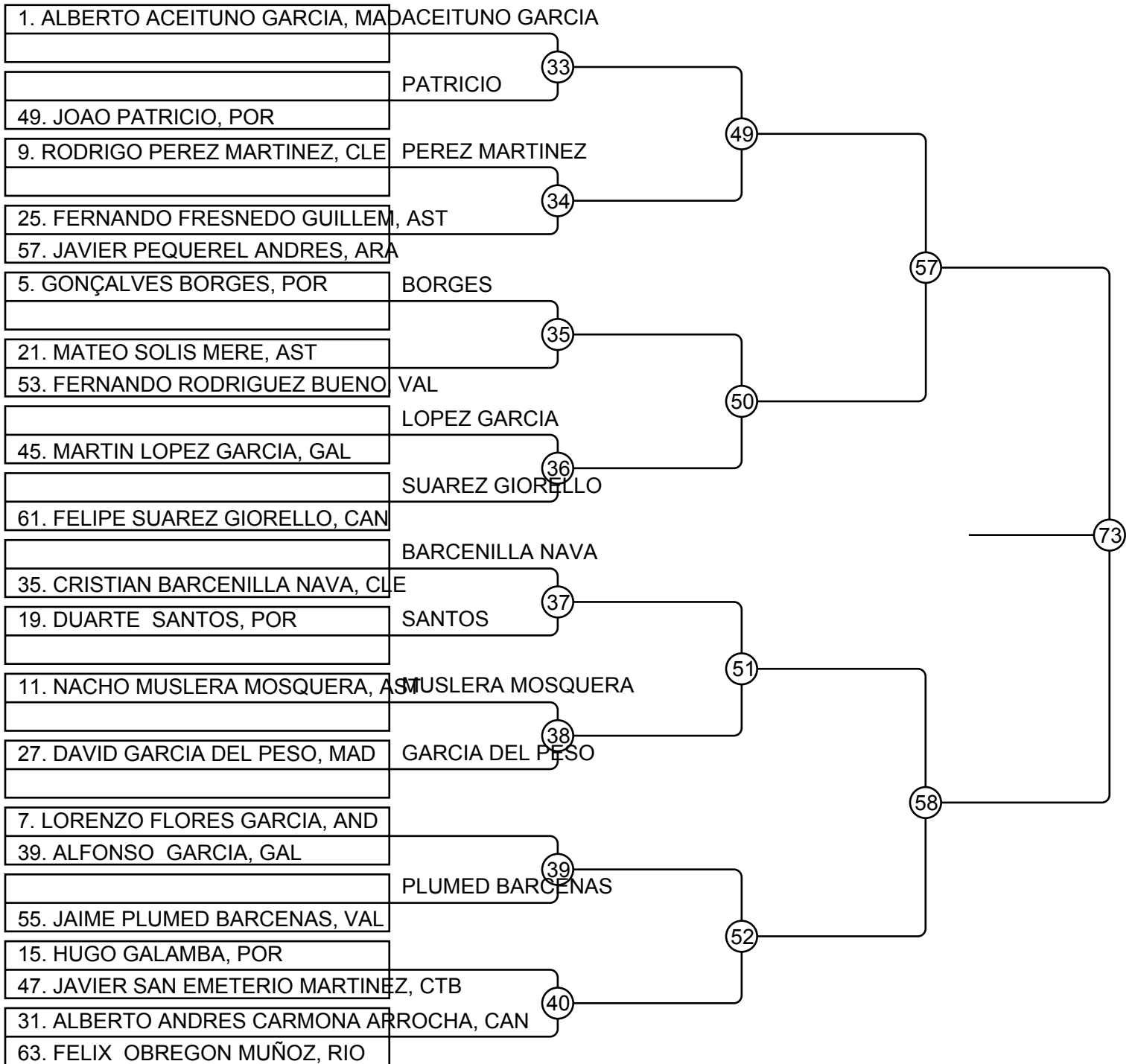

Infantil villa aviles 14 01/11/2014 Avilés Inf M -50 (2/3)

Competidores: 41

C

D

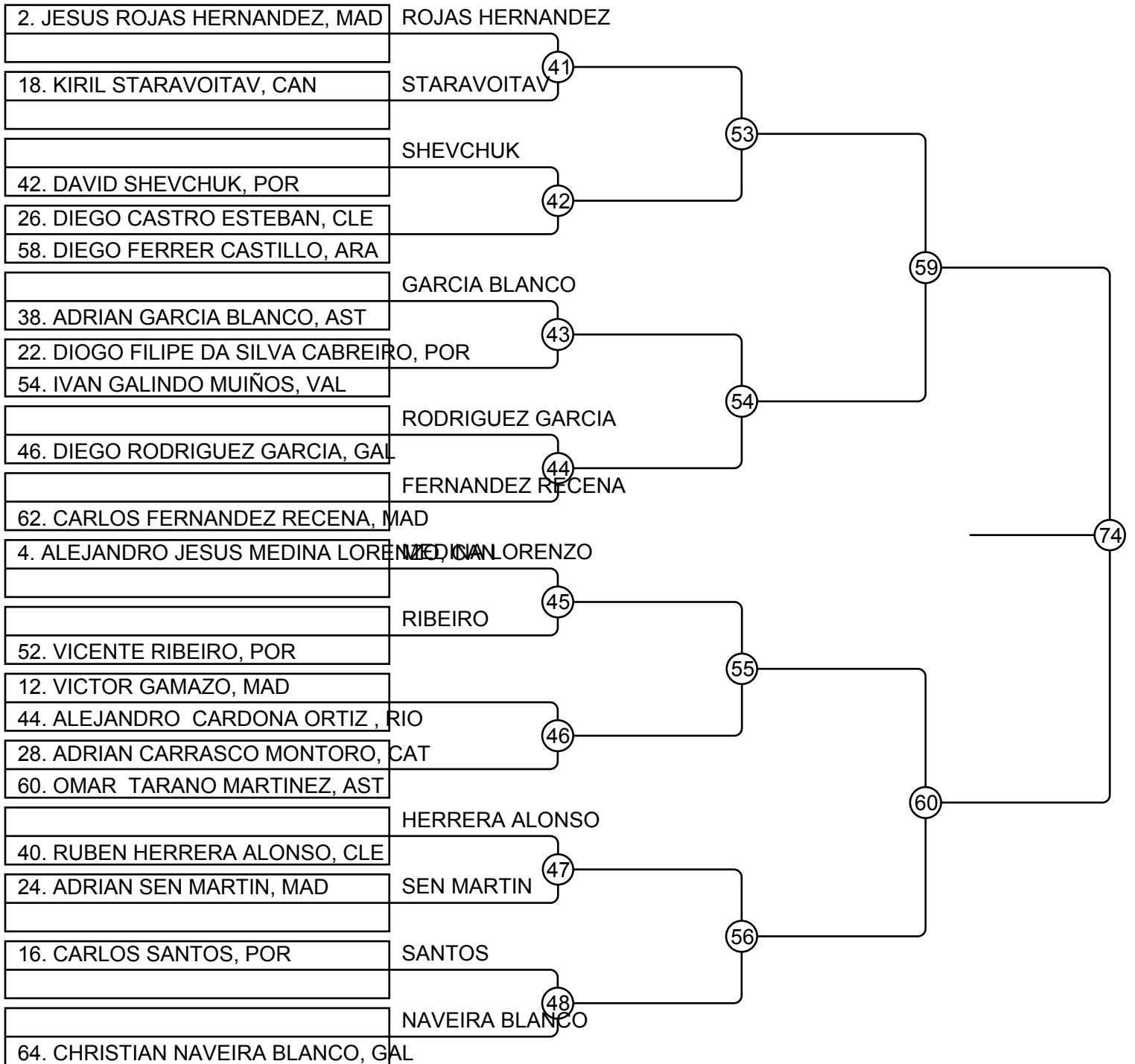

Infantil villa aviles 14 01/11/2014 Avilés Inf M -50 (3/3)

Competidores: 41

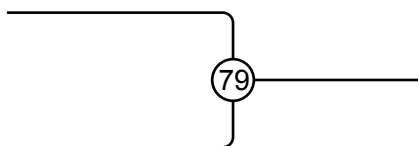
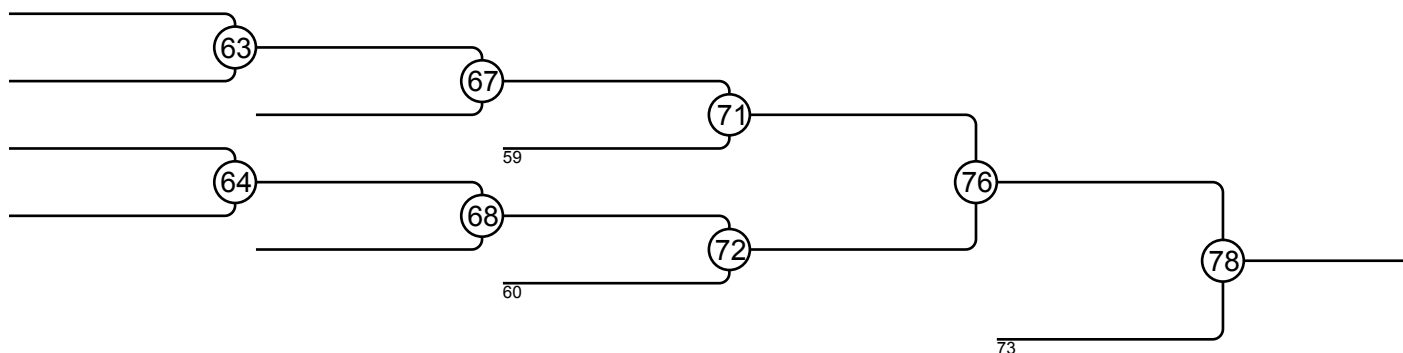
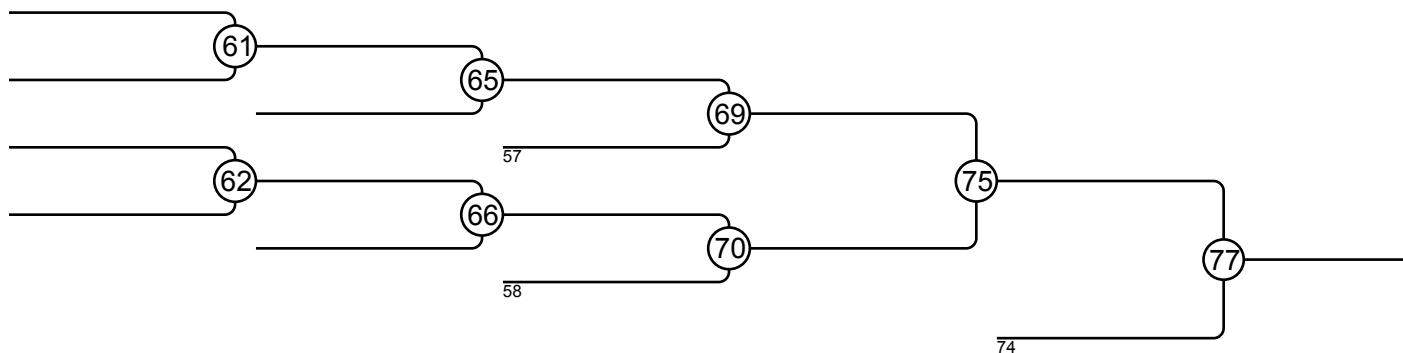

Clasificación

Pos.	Nombre
1	
2	
3	
3	
5	
5	
7	
7	

Infantil villa aviles 14 01/11/2014 Avilés Inf M -55

Competidores: 28

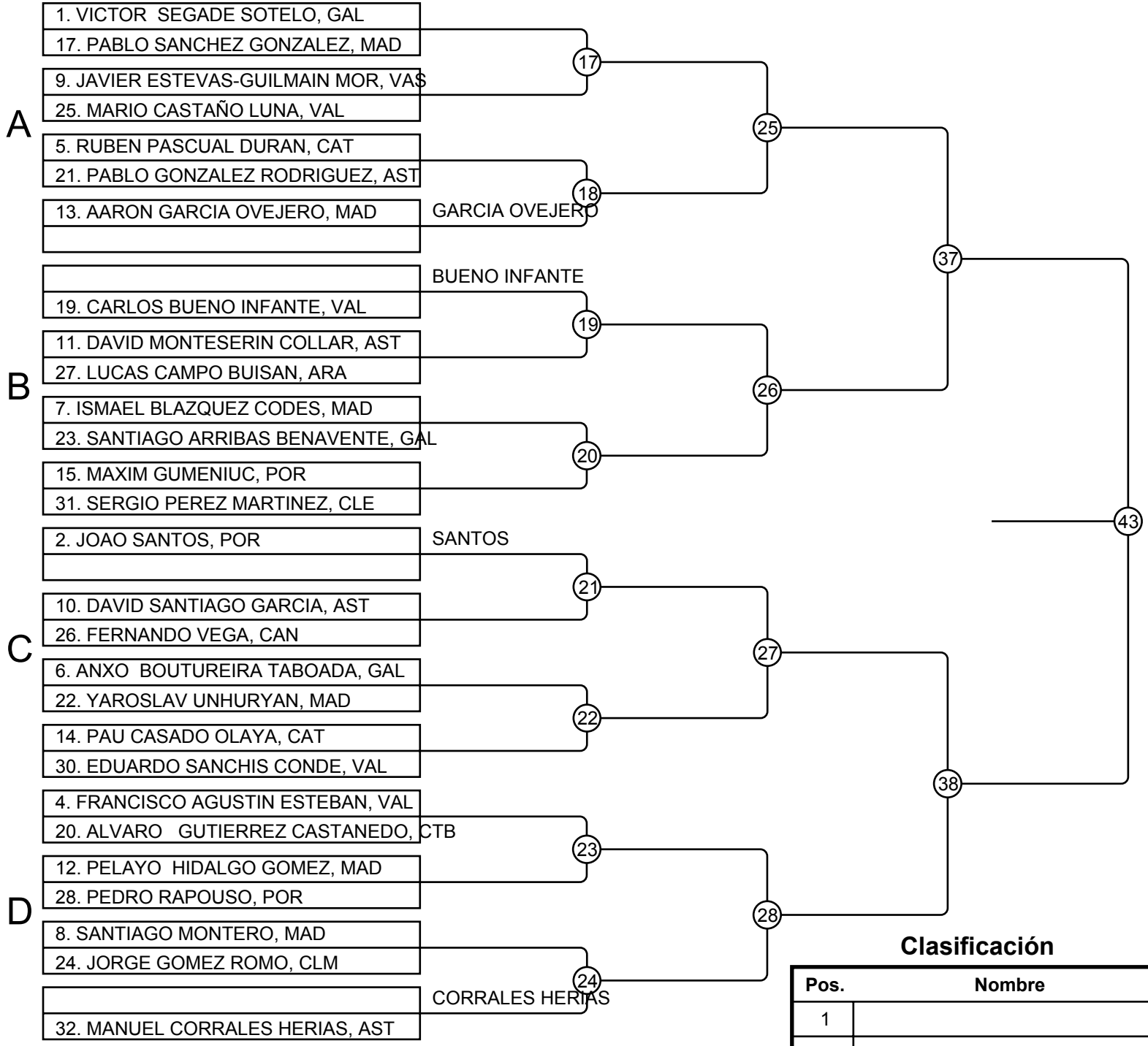

Clasificación

Pos.	Nombre
1	
2	
3	
3	
5	
5	
7	
7	

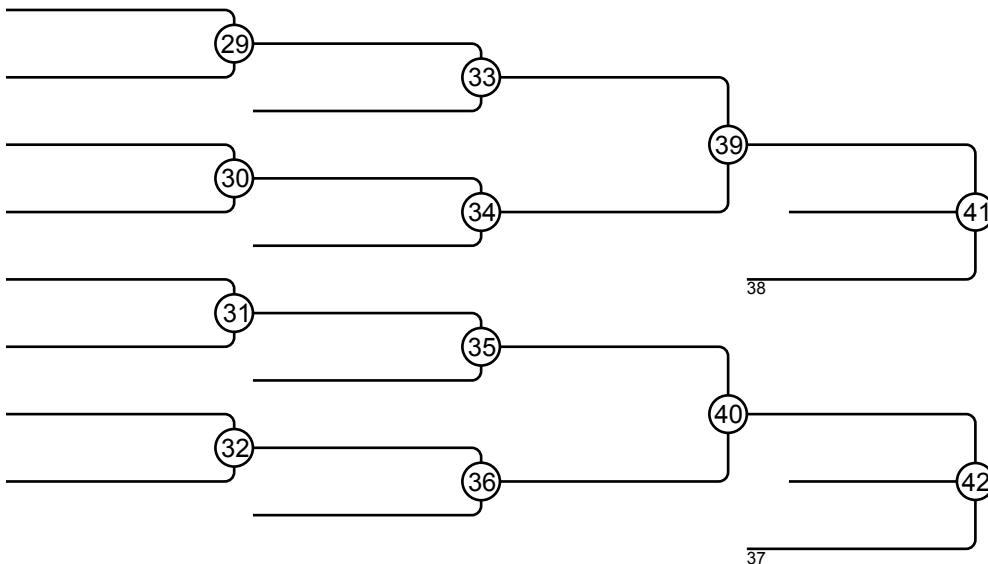

Infantil villa aviles 14 01/11/2014 Avilés Inf M -60

Competidores: 21

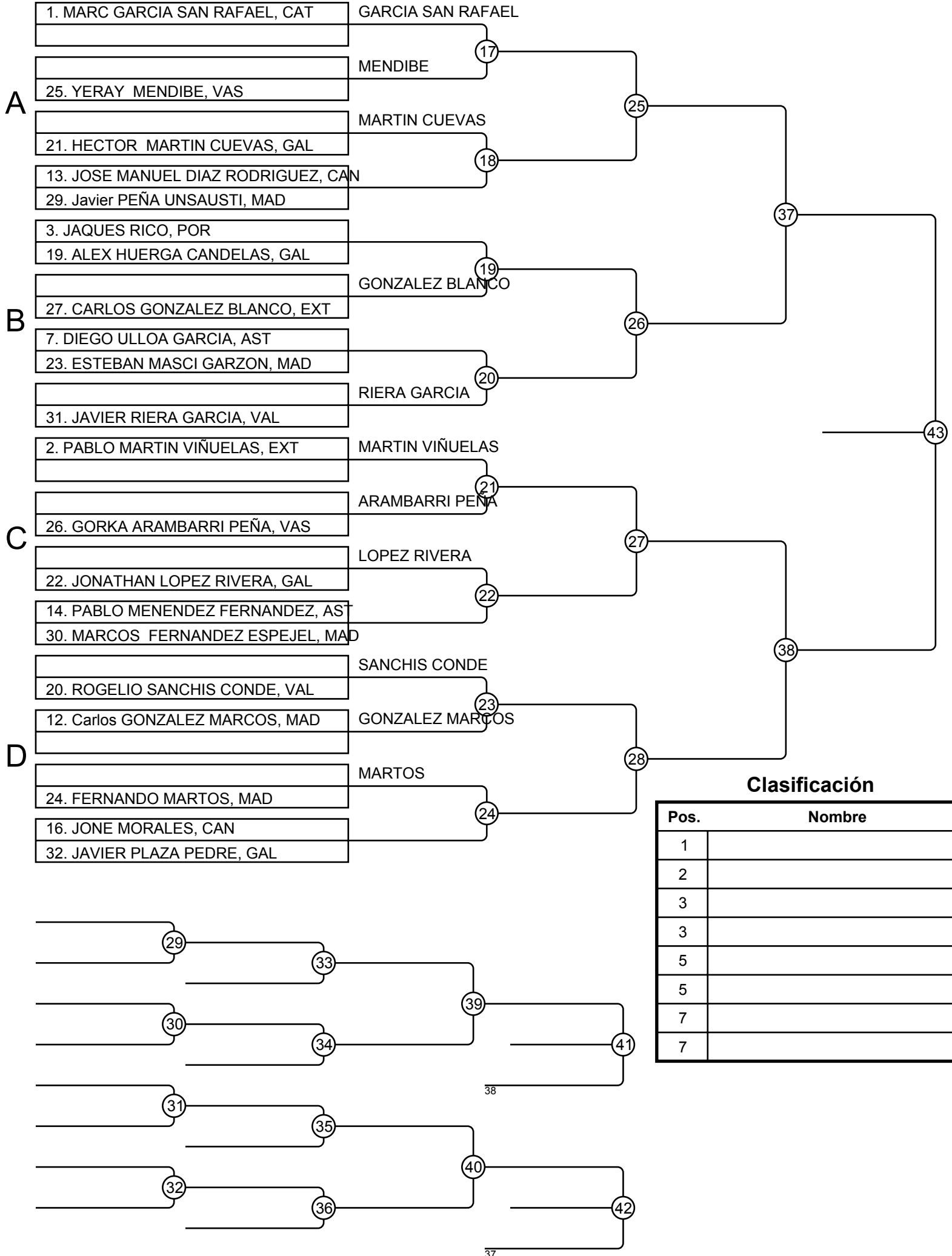

Infantil villa aviles 14 01/11/2014 Avilés Inf M -66

Competidores: 12

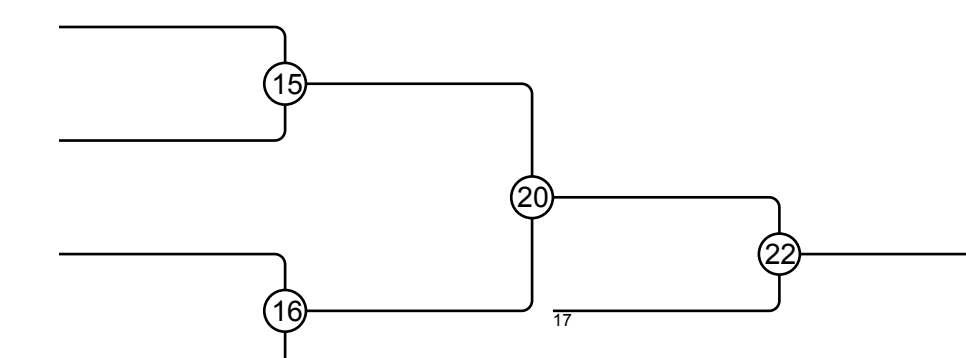
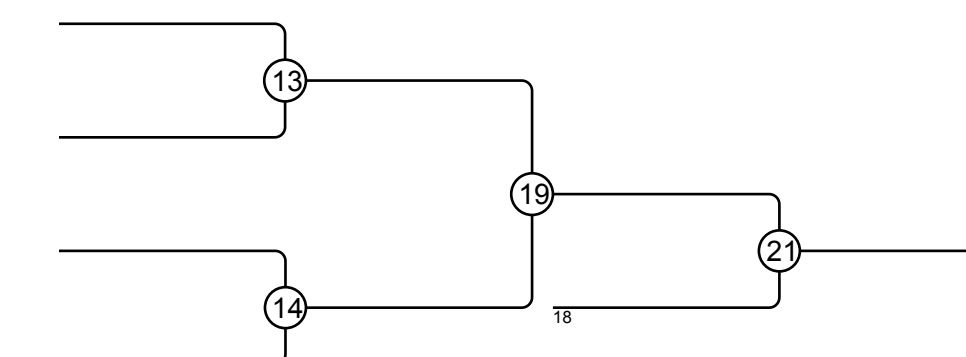
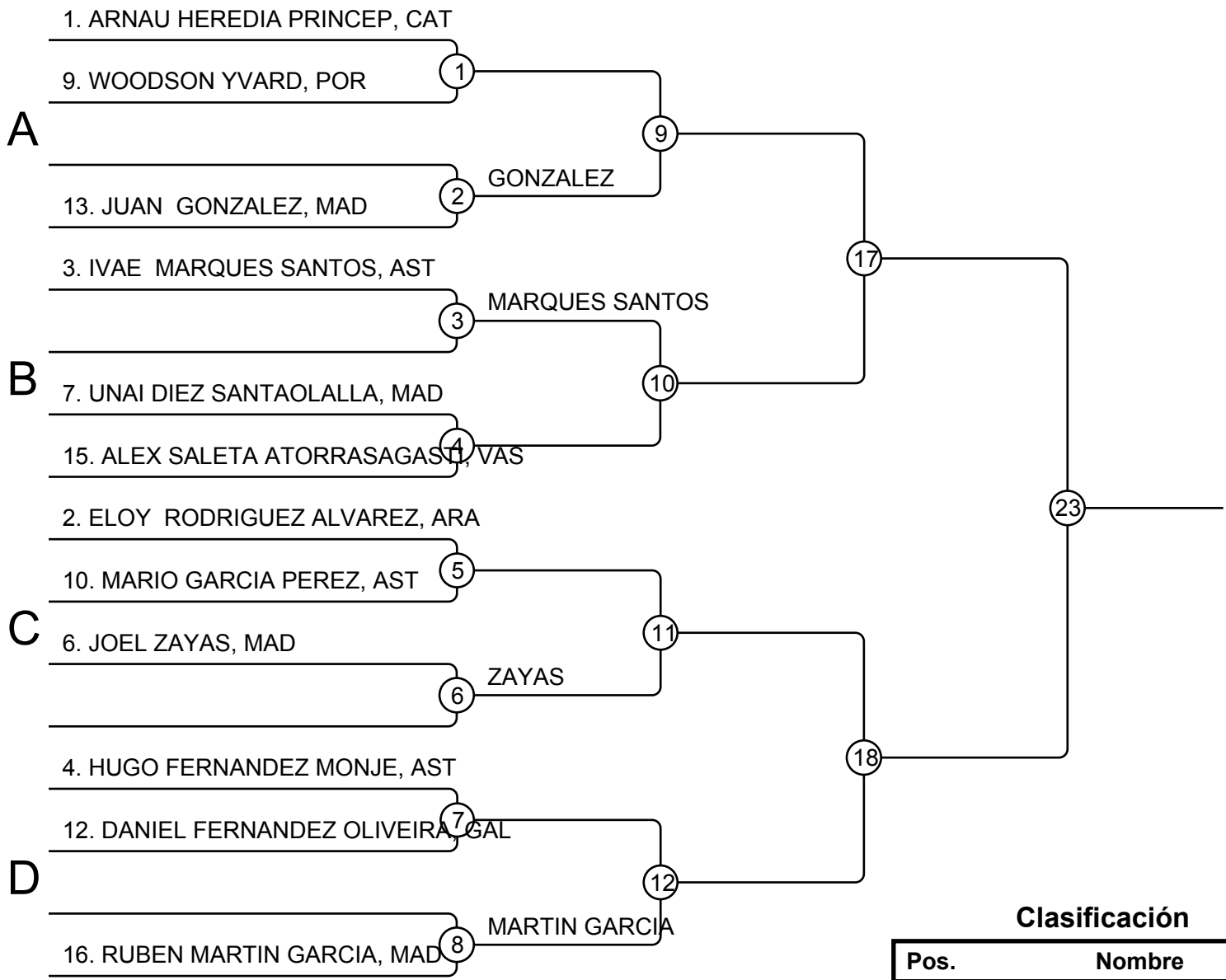

Clasificación

Pos.	Nombre
1	
2	
3	
3	
5	
5	
7	
7	

Infantil villa aviles 14 01/11/2014 Avilés Inf M +66

Competidores: 14

1. JON PASCUAL SAGARNA, VAS

PASCUAL SAGARNA

A

5. MATEO JONDAN CANGA, AST

13. ADAN BOHORQUEZ RAMOS, AST

3. VLADISLAO PARECHYN, ARA

11. ISMAEL SANCHEZ, AST

B

7. CARLOS CENTENO TERAN, CTB

15. ALEJANDRO DULZAIDES GARCIA, GAL

2. JOSE CARDOSO, POR

10. LUCA VIA AMETH, GAL

C

6. DAVID QUEVEDO MORA, VAL

14. ADRIAN GONZALEZ BLANCO, AST

4. SERGIO DIAZ FERNANDEZ, AST

DIAZ FERNANDEZ

D

8. BRIAN VERBO DAMERVAL, CLM

16. IVAN DE LA FUENTE, GAL

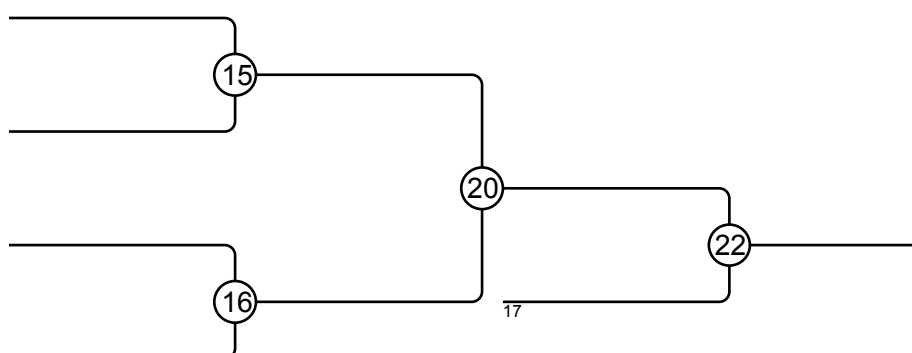
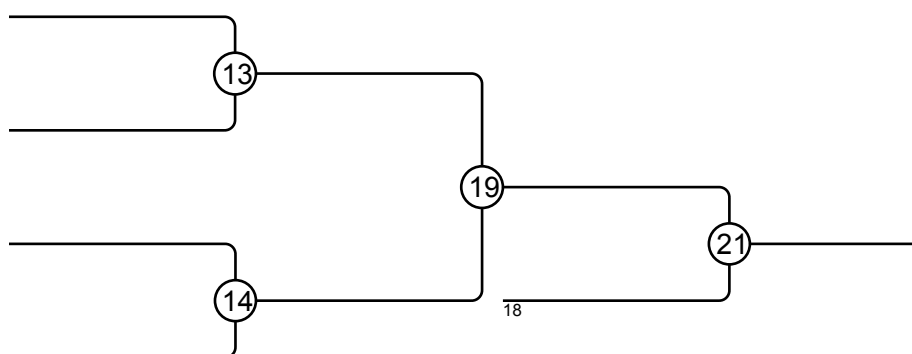

Clasificación

Pos.	Nombre
1	
2	
3	
3	
5	
5	
7	
7	